

Dialogannahme

ADAS CALIBRATION

Version 2024.05.16 – Prices on request

BBFAS 415

Beissbarth BB FAS 415 - the flexible front camera calibration device for multi-brand system solutions

Article number: 8 900 380 008

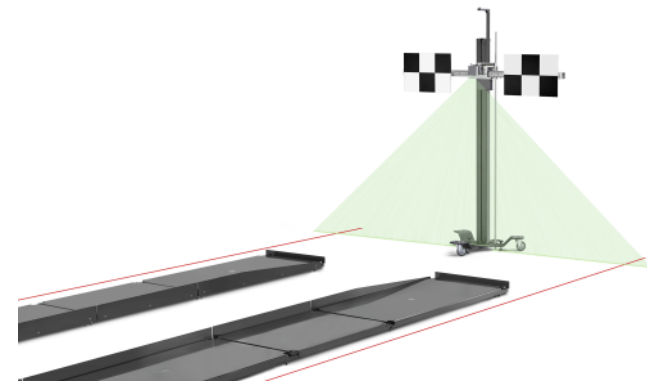
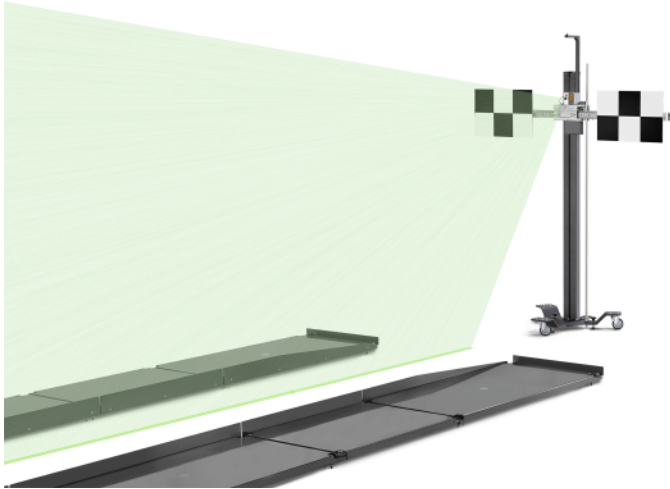

Front camera calibration with BBFAS 415 calibration device: Flexible, easy and precise

- static calibration of cameras e.g. Lane departure cameras, multifunction cameras
- Wide vehicle coverage through optional calibration Targets
- Fast, easy alignment to the vehicle's symmetrical axis or on to ground markings
- Alignment on to the vehicles track-width with optional accessories possible at any time
- Horizontal levelling according to precision spirit levels via three height-adjustable feet
- Precision crossbeam with slidingplate and fine adjusting screw
- Magnetic holding fixture for multi-brand calibration plates
- High power line laser module with low laser class (1M). Green laser diodes are particularly well visible to the human eye because the eye has its maximum spectral sensitivity in the green range.
- Optional: Compact storage box for modular calibration boards

Note: For adjusting the driver assistance systems, an OBD diagnostic device is also required

Scope of delivery:

- Precision crossbar with 2 magnetic sliding-plates for mounting of calibration Targets
- 4-wheel trolley with stable column for holding the crossbar
- Line laser module for aligning the calibration device
- Ruler for height adjustment

Note: Necessary calibration targets are not included

Distance measurement laser for BB FAS 415

Article number: 8 900 381 005

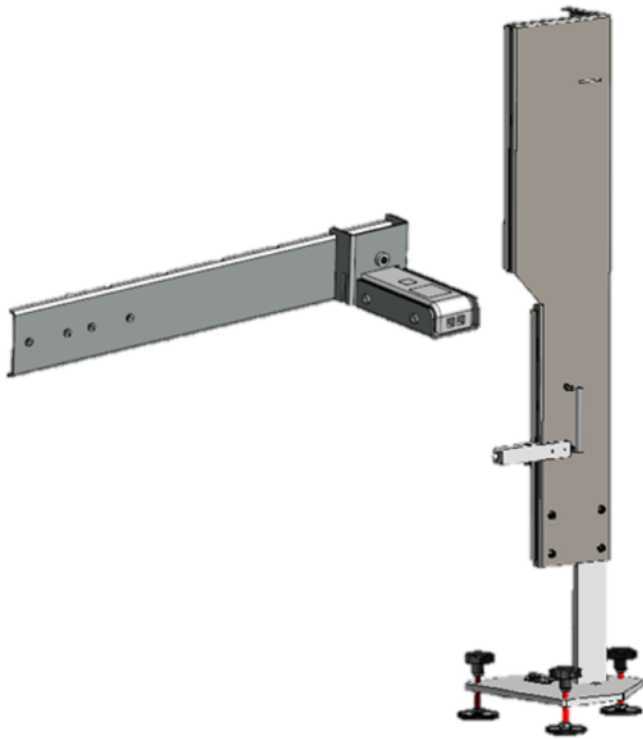

P-Assist

Article number: 8 900 381 138



- P-Assist wheel stands: Front and rear wheel stands for P-Assist laser alignment system for alignment to wheel-track.

Positioning target

Article number: 8 900 381 292



- Target panel for roof antennas for alignment with the vehicle's longitudinal axis

2-in-1 XXL calibration board | for VW front camera and multi-brand radar | Q.DAS

2-in-1 XXL calibration board with the pattern for calibrating front camera systems on VW Group vehicles. The newly reworked version in combination with Q.DAS allows users to also calibrate radar systems on all vehicles that require an even reflective service in front of the radar sensor. This enables radar calibration also on vehicles outside the VW Group.

Article number: 8 900 381 056

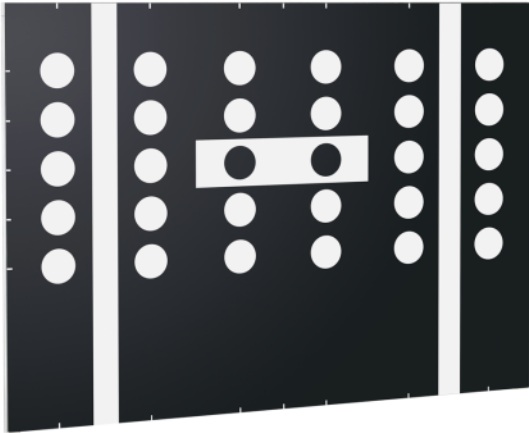

2-in-1 XXL calibration board with the pattern for calibrating front camera systems on VW Group vehicles. The newly reworked version in combination with Q.DAS allows users to also calibrate radar systems on all vehicles that require an even reflective service in front of the radar sensor. This enables radar calibration also on vehicles outside the VW Group. Single and double radar systems can be calibrated in the lowest height position, without any setup times or rotation of the target board. The height is infinitely adjustable to cover both low positioned radar systems as well as high positioned camera systems with only one calibration board. The purchase of the XXL calibration board does not require any further ACC reflector mirrors (8 900 381 150) for radar calibration! The required tilting positions are also possible with the XXL calibration board. Advantages:

- Camera calibration for VW Group vehicles and multi-brand OEM radar calibration in one
- No setup times, no rotation
- For single and double radars
- For passenger cars and transporter (very high transporters may only work in combination with Q.DAS Pro)
- Integrated tilting mechanism with 3 positions
- High quality materials and finishing with flat surface guarantee

Note: Only in combination with the Q.DAS frame.

eTarget Kit | Digital 15-in-1 solution

15-in-1 calibration patterns in one eTarget for faster and error-free target board selection.

Article number: 8 900 380 011



eTarget: fast and space-saving solution for workshops – broad manufacturer coverage includedeTarget is an innovative digital calibration target based on e-paper technology - unlike conventional monitors, beamers or other screen solutions.OEM-compliant calibration targets for precise and fast ADAS calibration with Q.DAS:

- Faster setup times, more space: 15 patterns in one eTarget
- Automatic pattern selection minimizes user errors
- Extremely high contrast, even from different viewing angles
- Reflective technology for all lighting conditions
- Integrated Bluetooth module for app communication
- Lightweight and robust housing
- Downward compatible with previous Beissbarth calibration solutions (BBFAS 1xxx, BBFAS 415)
- Battery operated and power saving – display is maintained even without power

Scope of deliveries:

- 2x eTarget with charging cable
- 1x Universal Type 4S (8 900 382 570)

Note: Automatic target selection requires active license for Q.mApp software.

Multi-Target starter kit 1

For articles to be ordered, see configuration. | Article number: 8 900 381 001



- Multi-Target starter kit 1 with storagebox

Targets included:

- Nissan Set 1 (8 900 381 139)
- Toyota (8 900 382 287)
- Mercedes 1 / Infiniti 2 (8 900 382 312)
- Mazda 1 (8 900 382 318)
- Honda 3 (8 900 382 349)
- Toyota 3 (8 900 382 355)
- Universal Target 1 (8 900 382 570)

Multi-Target starter kit 2

For articles to be ordered, see configuration. | Article number: 8 900 381 002



- Multi-Target starter kit 2 with storagebox

Targets included:

- Mercedes 1 / Infiniti 2 (8 900 382 312)
- Mercedes 2 (8 900 382 319)
- Universal Target 1 (8 900 382 570)

Calibration target set Nissan type 1

Article number: 8 900 381 139

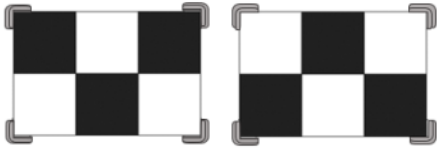

Nissan

- Qashqai [J11] year from 2013 to 2017-09
- Qashqai Facelift [J11] year from 2017-10
- X-Trail / Rouge [T32] Facelift year from 2017

Calibration target set Nissan type 2

Article number: 8 900 381 140

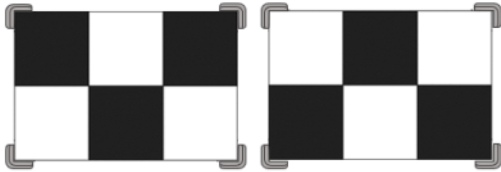

Infiniti

- QX60 formerJX [L50]
- QX70 [Y51] = FX_Serie year from 2013

MERCEDES-BENZ

- X-Klasse [470, 471] year from 2017

Nissan

- Altima [L34] year from 2019
- Leaf [ZE1] year from 2018
- Maxima [A36] year from 2016
- Maxima [A36] year from 2015 to 2016
- Micra [K14] year from 2017
- X-Trail / Rouge [T32] year from 2013 to 2016

Calibration target set Honda type 1

Article number: 8 900 381 143

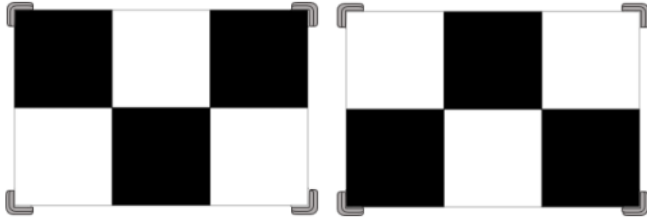

Honda [EU]

- Jazz / Fit [GK] year from 2015
- Civic (9) year from 2012 to 2016
- Civic Typ KG : year from 2016 to 2017
- HR-V [RU] year from 2015

Honda [US]

- Accord US year from 2013 to 2015
- Civic (5 door) year from 2016 to 2017
- Civic (Hybrid) year from 2012 to 2015
- CR-V year from 2017
- HR-V year from 2016 to 2017

Calibration target Honda type 2

Article number: 8 900 382 297



Calibration target Honda type 3

Article number: 8 900 382 349



Honda [EU]

- Accord (9) [CR] year from 2014
- Civic Non KG: year from 2016 to 2017
- CR-V (4) [RM] year from 2012 to 2015
- CR-V (4) [RM] year from 2015 to 2017

Calibration target Mazda type 1

Article number: 8 900 382 318



MAZDA

- CX 3 [DK] year from 2015
- CX 5 [KE] year from 2012 to 2016
- CX 9 [TB]
- MX5 [ND]
- Serie-2 [DJ, DL]
- Series-3 [BM] year from 2013 to 2016-05
- Series-6 [GJ] year to 2016

Calibration target set Mazda type 2

Article number: 8 900 381 234

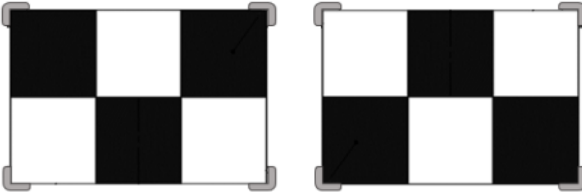

MAZDA

- CX 5 [KF] year from 2017
- Series-3[BN] year from 2016-06
- Series-6 [GL] year from 2017

Calibration target set Mitsubishi type 1

Article number: 8 900 381 218

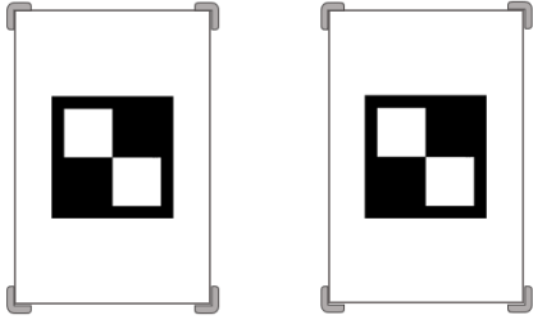

MITSUBISHI

- ASX / Outlander Sport [GA] year from 2018
- Eclipse Cross [GK] year from 2018
- Outlander III Facelift / PHEV year from 2017

Calibration target Toyota type 1

Article number: 8 900 382 287



LEXUS

- ES300h ES450h [V6#] year from 2012 to 2015
- GS-F, GS200t, GS250, GS300h GS350 GS450h [L1#] year from 2012
- LS460, LS600h [F4#] year from 2007
- NX200 NX300h [Z1#]
- RC-F, RC200t, RC350 [C1#] year from 2014

TOYOTA

- Auris / Corolla [E18#] with SafetySense 3-Step year from 2015 to 2018
- Avensis [T27#] with SafetySense 3-Step year from 2015
- Aygo [B4#] with SafetySense 3-Step year from 2015
- Camry [V5#] year from 2014
- C-HR X10/X50 year from 2017
- Highlander, Kluger [U5] year from 2013
- Mirai [JPD10] year from 2015
- Prius [W30] Prius [W40] year from 2009 to 2015
- RAV4 [A4] year from 2012 to 2015
- Verso [R2#] with SafetySense 3-Step year from 2016
- Yaris [P13#] with SafetySense 3-Step year from 2015 to 2017
- Yaris [P13#] with SafetySense 3-Step year from 2017

Calibration target Toyota type 2

Article number: 8 900 382 328



CITROEN

- C1 [B4] year from 2014

PEUGEOT [EU]

- 108 [B3]

TOYOTA

- Auris / Corolla [E18#] with SafetySense 1-Step year from 2015 to 2018
- Avensis [T27#] with SafetySense 1 -Step year from 2015
- Aygo [B4#] with SafetySense 1-Step year from 2015
- Verso [R2#] with SafetySense 1-Step year from 2016
- Yaris [P13#] with SafetySense 1-Step year from 2015 to 2017
- Yaris [P13#] with SafetySense 1-Step year from 2017

Calibration target Toyota type 3

Article number: 8 900 382 355



LEXUS

- ES300h ES450h [V6#] year from 2015
- IS200t IS300h IS350 [E3#]
- LS500h LS600h [F5#] w Mono-Front-Camera year from 2017
- LS500h LS600h [F5#] w Stereo-Front-Camera year from 2017
- LX570 [J20] year from 2007
- RX200t, RX350, RX450h, [L2#] year from 2015-09

TOYOTA

- Hilux_[N12, N13] year from 2015
- Prius [W50] year from 2015
- RAV4 [A4] year from 2015 to 2018

Calibration target Subaru type 2S

With slot for the alignment laser

Article number: 8 900 382 608

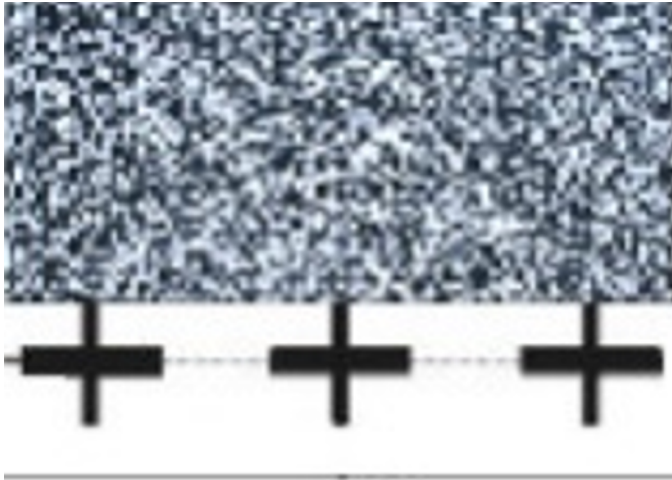

SUBARU

- Forester G3 (AUS), [SH /S13] year from 2012
- Forester G4 (AUS), [SJ] year from 2014
- Impreza G4 (AUS), [GJ,GP/G23] year from 2011 to 2015
- Legacy [BM,BR / B13] year from 2012
- Outback [BR / B14] year from 2012 to 2015
- XV / Crosstrek [GP, G33] year from 2011 to 2015

Calibration target Subaru type 3S

With slot for the alignment laser

Article number: 8 900 382 590

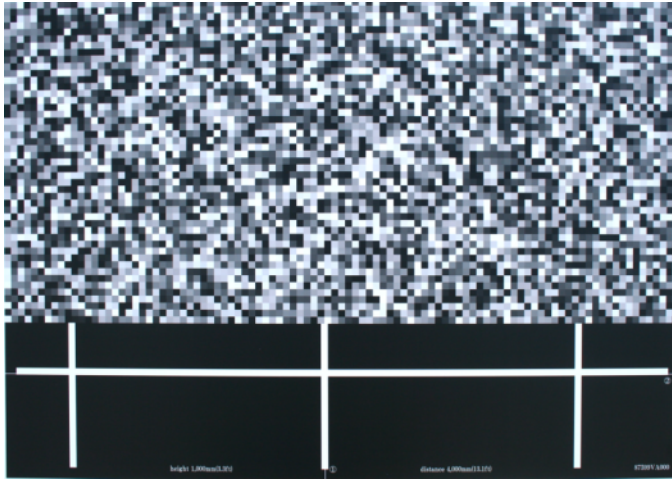

SUBARU

- Impreza G4, [GJ,GP/G13] year from 2011 to 2017
- Impreza G5 , [GK,GT] year from 2018
- Legacy [BN,BS] year from 2014
- Levorg [GP / V10,VM] year from 2014
- Liberty (au) [BN] year from 2014
- Outback [BR / B14] year from 2015
- Outback [BS /B15] year from 2014
- WRX [VA /V10] year from 2014
- XV / Crosstrek [GP, G33] year from 2015

Calibration target Kia / Hyundai type 2

Article number: 8 900 382 320

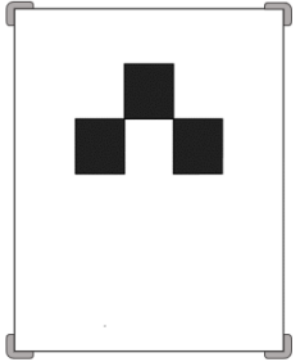

Hyundai

- H350 [EU] year from 2015

Calibration target Kia / Hyundai type 3

Article number: 8 900 382 316



Hyundai

- Equus [VI] year from 2016
- Genesis [BH] year from 2011 to 2014
- SantaFe [DM] Grand-SantaFe [NC] Sport-SantaFe MaxCruise [NC] year from 2015

KIA

- Cadenza / K7 [VG] year from 2009 to 2016
- Sorento [XM] year from 2009 to 2015

Calibration target Mercedes/Infinity type 1

Calibration target for Mercedes (passenger cars)

Article number: 8 900 382 312



MERCEDES-BENZ

- A-Klasse [176] year from 2012 to 2018
- B-Klasse [246] year from 2011-11 to 2018-11
- C-Klasse [204] +Facelift year from 2007 to 2014
- C-Klasse [205] year from 2014
- CL [216] year from 2006 to 2013
- CLA [117] year from 2013 to 2019
- CLS [218] year from 2011 to 2018
- E-Klasse [212] year from 2012 to 2016
- E-Klasse [213] year from 2016
- E-Klasse Coupe [207] year from 2009 to 2016
- E-Klasse Coupe [238] year from 2016
- GLA [156] year from 2013 to 156]
- GLC [253] year from 2015
- GLE [292] year from 2015 to 2019
- GLK [204] + Facelift year from 2008 to 2015
- M-Klasse (GL-Klasse) GLE, GLS [166] Camera system 4.0.1 year from 2011 to 2015
- M-Klasse (GL-Klasse) GLE, GLS [166] Camera system 4.0 year from 2011 to 2015
- M-Klasse [GL-Klasse] [164] year from 2006 to 2012
- S-Klasse [221] year from 2005 to 2013
- S-Klasse [222] year from 2013
- S-Klasse Coupe [217] year from 2014 to 217]
- SLK, SLC [172] year from 2011
- SL-Klasse [231] year from 2012
- SLR [190] year from 2014 to 2016
- V-Klasse[447] / Vito [448] year from 2014

Calibration target Mercedes / Infinity type 2

Calibration target for Mercedes (Sprinter) / Infinity

Article number: 8 900 382 319

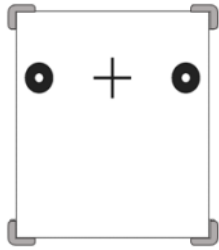

MERCEDES-BENZ

- Sprinter [W909] year from 2013 to 2019
- Sprinter 2500 / 3500 [W906] year from 2006 to 2013

VOLKSWAGEN

- Crafter [2E,2F] year from 2016 to 2017

Calibration target Universal type 6S

With slot for the alignment laser

Article number: 8 900 382 571



CITROEN

- C3 Aircross [A88] year from 2017
- DS3 Crossback [D34] year from 2019
- DS7 Crossback [X74] year from 2017
- Jumper 3 / Relay 3 [U9] year from 2014

FIAT

- 500X [334] year from 2015
- Ducato year from 2014

Hyundai

- Elantra [ADA] year from 2017
- Genesis [DH] year from 2014
- i10 [IA] year from 2017
- i20, i20 Active [GB] year from 2015
- i30 [GD] year from 2015
- i30 [PDE] year from 2017
- i40 [VF] year from 2012
- IONIQ [AE-HEV] year from 2017
- SantaFe[DM] year from 2016
- Sonata [LFA] year from 2016
- Tucson [TL] year from 2016

Jeep

- Renegade [BU] year from 2015

KIA

- Cadenza / K7 [YG] year from 2016
- Carens / Rondo [RP] year from 2014
- Ceed / Pro Ceed [JD] year from 2013
- Niro [DE] E-Niro year from 2017
- Optima [JF] year from 2016

- Optima [TF] year from 2015
- Rio (YB) year from 2017
- Sorento [UM] year from 2015
- Soul [PS] E-Soul year from 2015

OPEL

- Crossland X year from 2017
- Grandland X year from 2018

PEUGEOT [EU]

- 3008 II year from 2018
- 508 II year from 2018
- Boxer-3 / Manager [U9]

TESLA

- Model S year from 2016-10
- Model X year from 2016-10

Calibration target set Universal type 2

Article number: 8 900 381 142

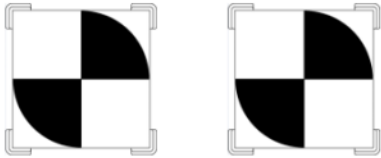

NISSAN

- Cima; Fuga [Y51] = Infinity Q70
- NV400 [X62]
- Patrol [Y62] year from 2010

OPEL

- Movano-B

RENAULT

- (Grand) Espace V [xFC] year from 2015
- (Grand) Scenic III [J95] year from 2012
- Kadjar [HL/ HZH, HFE] year from 2015 to 2018
- Koleos II [HZG, HZJ] year from 2016
- Master III [x62] year from 2010
- Megane III [x95] year from 2008
- Megane IV [xFB] year from 2016
- Talisman [xFD] year from 2015
- Twingo III [B07] year from 2014

SMART

- ForFour [543.0] year from 2014
- ForTwo [543-3-4] year from 2014

Target storage box empty

Article number: 1 690 381 217



- Empty storagebox for storing the multi brand targets for front camera calibration.

ACC reflector mirror | for radar calibration

ACC reflector mirror for adjusting the ACC sensor.

Article number: 8 900 381 150

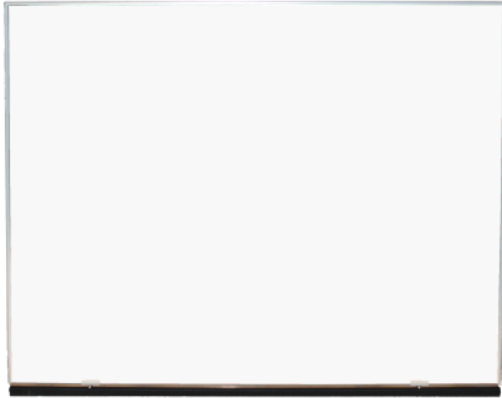

BBFAS 1415

Article number: 8 900 380 007

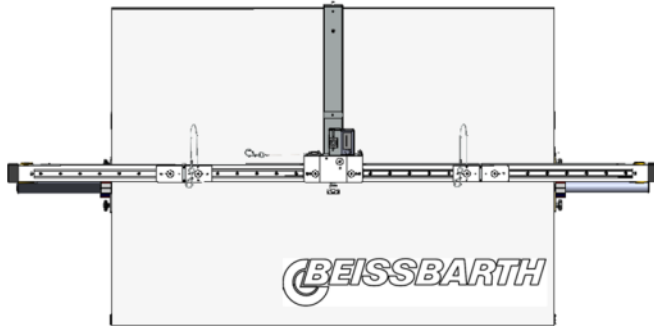

- Comprehensive coverage of the front camera calibration will be achieved by upgrading the system with the BBFAS 1415. In combination with the optional calibration targets the service can be extended for all important European, Japanese and Korean vehicle manufacturers.
- You simply need to mount the precision measurement bar, which is able to carry the calibration targets, on the BBFAS 1000 base frame and you are ready to go. Precise orientation of the frame and the target relative to the driving axle is made possible with the Beissbarth 3D wheel alignment system or with Beissbarth CCD system.

Q.DAS Standard | ADAS Calibration after wheel alignments

Modular solution for ADAS calibration of forward-facing and safety-critical radar, camera, and LIDAR systems. Standard version for workshops with low to medium calibration volumes.

Article number: 8 900 380 010



Q.DAS: OEM-compliant ADAS calibration in combination with wheel alignment

Q.DAS is a modular solution for the calibration of forward-facing, safety-relevant radar, camera and LIDAR systems. Configure your system depending on the volume, budget and available space.

Q.DAS Standard:

- Safety-relevant driver assistance systems: Radar and camera
- Vehicle class: Cars
- Calibration volume in the workshop: low to medium
- Height adjustment: Motorized up to 1700 mm
- Works with all camera calibration targets: Yes
- Supports eTargets: Yes
- Distance adjustment without re-leveling: 200 mm
- Center offset adjustment without re-leveling: 200 mm

Advantages of the Q.DAS system:

1. Digital instead of analog:

- Camera-based positioning via live display
- No plump bobs or measuring tapes
- Full control over entire calibration
- Direct specs instead of manual value transfer*

2. Wheel alignment and ADAS calibration as one process

- No retooling
- No moving of measuring devices
- Permanently ready for use
- Guided instructions for setup and positioning
- Automatic compensation of different installation heights
- Meets highest accuracy requirements of OEMs

3. Modular calibration solution for every workshop

- Free choice of calibration targets and radar mirrors
- Configuration according to calibration volume, budget and space conditions
- No fixed commitment to only one diagnostic tester
- Integrated X-Y slider minimizes leveling
- Motorized height adjustment

Just a few steps to the right system for ADAS calibration

Scope of deliveries:

- 1x Modular Q.DAS frame, without targets or radar mirrors
- 1x Q.mApp software (Android) and license for activation (1 year)
- 1x Digital Bluetooth laser distance gauge

*Costs apply: Requires active Q.mApp license in combination with Q.Lign wheel aligner

Q.DAS Standard | ADAS Calibration after wheel alignments | 110V Version

Modular solution for ADAS calibration of forward-facing and safety-critical radar, camera, and LIDAR systems. Standard version for workshops with low to medium calibration volumes.

Article number: 8 900 380 020



Q.DAS: OEM-compliant ADAS calibration in combination with wheel alignment

Q.DAS is a modular solution for the calibration of forward-facing, safety-relevant radar, camera and LIDAR systems. Configure your system depending on the volume, budget and available space.

Q.DAS Standard:

- Safety-relevant driver assistance systems: Radar and camera
- Vehicle class: Cars
- Calibration volume in the workshop: low to medium
- Height adjustment: Motorized up to 1700 mm
- Works with all camera calibration targets: Yes
- Supports eTargets: Yes
- Distance adjustment without re-leveling: 200 mm
- Center offset adjustment without re-leveling: 200 mm

Advantages of the Q.DAS system:

1. Digital instead of analog:

- Camera-based positioning via live display
- No plump bobs or measuring tapes
- Full control over entire calibration
- Direct specs instead of manual value transfer*

2. Wheel alignment and ADAS calibration as one process

- No retooling
- No moving of measuring devices
- Permanently ready for use
- Guided instructions for setup and positioning
- Automatic compensation of different installation heights
- Meets highest accuracy requirements of OEMs

3. Modular calibration solution for every workshop

- Free choice of calibration targets and radar mirrors
- Configuration according to calibration volume, budget and space conditions
- No fixed commitment to only one diagnostic tester
- Integrated X-Y slider minimizes leveling
- Motorized height adjustment

Just a few steps to the right system for ADAS calibration

Scope of deliveries:

- 1x Modular Q.DAS frame, without targets or radar mirrors
- 1x Q.mApp software (Android) and license for activation (1 year)
- 1x Digital Bluetooth laser distance gauge

*Costs apply: Requires active Q.mApp license in combination with Q.Lign wheel aligner

US/JP Version with 110V

Q.DAS Pro | ADAS Calibration after wheel alignments

Modular solution for ADAS calibration of forward-facing and safety-critical radar, camera, and LIDAR systems. Pro version for workshops with high calibration volumes.

Article number: 8 900 380 012

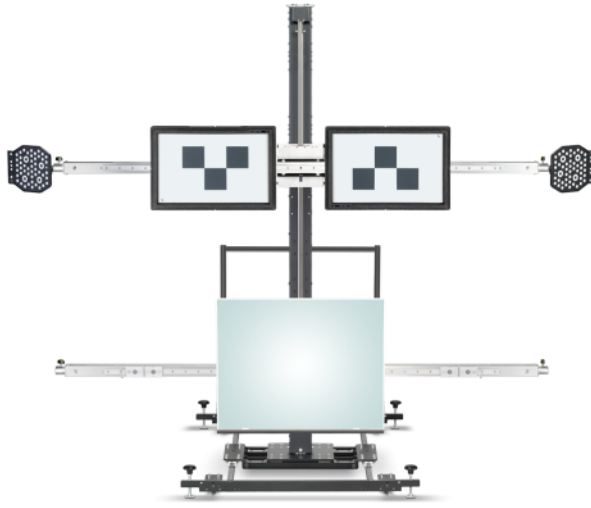

Q.DAS: OEM-compliant ADAS calibration in combination with wheel alignment

Q.DAS is a modular solution for the calibration of forward-facing, safety-relevant radar, camera and LIDAR systems. Configure your system depending on the volume, budget and available space.

Q.DAS Pro:

- Safety-relevant driver assistance systems: Radar and camera
- Vehicle class: Cars and light commercial vehicles
- Calibration volume in the workshop: high
- Height adjustment: Motorized up to 2050 mm
- Works with all camera calibration targets: Yes
- Supports eTargets: Yes
- Distance adjustment without re-leveling: 900 mm
- Center offset adjustment without re-leveling: 200 mm

Advantages of the Q.DAS system:

1. Digital instead of analog:

- Camera-based positioning via live display
- No plump bobs or measuring tapes
- Full control over entire calibration
- Direct specs instead of manual value transfer*

2. Wheel alignment and ADAS calibration as one process

- No retooling
- No moving of measuring devices
- Permanently ready for use
- Guided instructions for setup and positioning
- Automatic compensation of different installation heights
- Meets highest accuracy requirements of OEMs

3. Modular calibration solution for every workshop

- Free choice of calibration targets and radar mirrors
- Configuration according to calibration volume, budget and space conditions
- No fixed commitment to only one diagnostic tester
- Integrated X-Y slider minimizes leveling
- Motorized height adjustment

Just a few steps to the right system for ADAS calibration

Scope of deliveries:

- 1x Modular Q.DAS frame, without targets or radar mirrors
- 1x Q.mApp software (Android) and license for activation (1 year)
- 1x Digital Bluetooth laser distance gauge

*Costs apply: Requires active Q.mApp license in combination with Q.Lign wheel aligner

Q.DAS Pro | ADAS Calibration after wheel alignments | 110V

Modular solution for ADAS calibration of forward-facing and safety-critical radar, camera, and LIDAR systems. Pro version for workshops with high calibration volumes.

Article number: 8 900 380 022

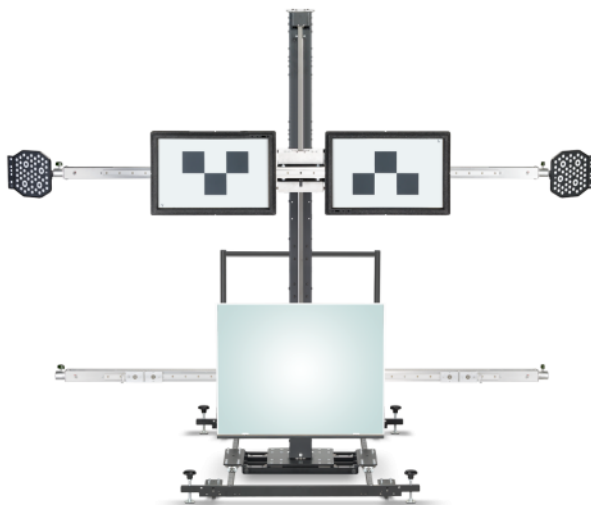

Q.DAS: OEM-compliant ADAS calibration in combination with wheel alignment. Q.DAS is a modular solution for the calibration of forward-facing, safety-relevant radar, camera and LIDAR systems. Configure your system depending on the volume, budget and available space. Q.DAS Pro:

- Safety-relevant driver assistance systems: Radar and camera
- Vehicle class: Cars and light commercial vehicles
- Calibration volume in the workshop: high
- Height adjustment: Motorized up to 2050 mm
- Works with all camera calibration targets: Yes
- Supports eTargets: Yes
- Distance adjustment without re-leveling: 900 mm
- Center offset adjustment without re-leveling: 200 mm

Advantages of the Q.DAS system:

1. Digital instead of analog:

- Camera-based positioning via live display
- No plump bobs or measuring tapes
- Full control over entire calibration
- Direct specs instead of manual value transfer*

2. Wheel alignment and ADAS calibration as one process

- No retooling
- No moving of measuring devices
- Permanently ready for use
- Guided instructions for setup and positioning
- Automatic compensation of different installation heights
- Meets highest accuracy requirements of OEMs

3. Modular calibration solution for every workshop

- Free choice of calibration targets and radar mirrors
- Configuration according to calibration volume, budget and

space conditions

- No fixed commitment to only one diagnostic tester
- Integrated X-Y slider minimizes leveling
- Motorized height adjustment

Just a few steps to the right system for ADAS calibration

Scope of deliveries:

- 1x Modular Q.DAS frame, without targets or radar mirrors
- 1x Q.mApp software (Android) and license for activation (1 year)
- 1x Digital Bluetooth laser distance gauge

*Costs apply: Requires active Q.mApp license in combination with Q.Lign wheel aligner

US/JP Version with 110V

Q.mApp | License Key 365

License for Q.mApp software for quicker positioning with Q.Lign, automatic ADAS specs through vehicle selection, complete ADAS documentation for third parties.

Article number: 8 900 388 001



Q.mApp: Safe and Fast ADAS Calibration

ADAS calibration can be time-consuming and complex, especially when procedures, equipment, and positions vary greatly among different OEMs. At the same time, safe and successful ADAS calibration requires thorough attention to detail. But who can keep track of it all?

ADAS calibration positioning made simple

Q.mApp guides the user through the setup and positioning sequence for every OEM, regardless of static or dynamic calibration. Selecting a vehicle and model immediately provides you with:

- Necessary equipment for ADAS calibration
- Step-by-step instructions to correctly position ADAS fixture and targets
- Height, distance, and center offsets for target placement

One ecosystem: Q.mApp fully integrates wheel alignment and ADAS calibration

By integrating wheel alignment and ADAS calibration, Q.mApp ensures systems are performing as set out by OEMs. In combination with Q.Lign, ADAS calibration becomes simpler than ever:

- Automatic compensation of height offsets
- Realtime positioning of ADAS fixture to OEM specs (Height, distance, offset, yaw angle)
- Compensation of runout and clamping errors
- Ensuring straight-ahead mode during calibration
- Rear axle readings and ADAS positions in one printout

Easy installation of Q.mApp

Q.mApp can be installed on any Android-based tablet or directly on the one delivered with your Q.Lign system! To use the full potential of Q.mApp, a registration & activation is required:

- Download the .apk file of Q.mApp: Download Link Q.mApp
- Install on the Android tablet of your choice
- Order a license key card through your local dealer (supplied with all Q.DAS systems)
- Enter your license key on base-licensecenter.com
- Unlock all features of Q.mApp with activation key received from the License Center

Find detailed installation instructions here: [Q.mApp Installation Guide](#)

Scope of delivery:

- Key Card with activation code for 365 days.

Q.DAS



Q.DAS Standard | ADAS Calibration after wheel alignments

Article number: 8 900 380 010

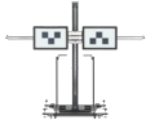

Q.DAS Standard | ADAS Calibration after wheel alignments | 110V Version

Article number: 8 900 380 020



Q.DAS Pro | ADAS Calibration after wheel alignments

Article number: 8 900 380 012



Q.DAS Pro | ADAS Calibration after wheel alignments | 110V

Article number: 8 900 380 022

Q.mApp Software



Q.mApp | License Key 365

Article number: 8 900 388 001

Without wheel aligner

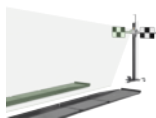

BBFAS 415

Article number: 8 900 380 008



Distance measurement laser for BB FAS 415

Article number: 8 900 381 005



P-Assist

Article number: 8 900 381 138



Positioning target

Article number: 8 900 381 292

Target Shop



2-in-1 XXL calibration board | for VW front camera and multi-brand radar | Q.DAS

Article number: 8 900 381 056



eTarget Kit | Digital 15-in-1 solution

Article number: 8 900 380 011



Multi-Target starter kit 1

Article number: 8 900 381 001

For articles to be ordered, see configuration.



Multi-Target starter kit 2

Article number: 8 900 381 002

For articles to be ordered, see configuration.



Calibration target set Nissan type 1

Article number: 8 900 381 139



Calibration target set Nissan type 2

Article number: 8 900 381 140



Calibration target set Honda type 1

Article number: 8 900 381 143



Calibration target Honda type 2

Article number: 8 900 382 297



Calibration target Honda type 3

Article number: 8 900 382 349



Calibration target Mazda type 1

Article number: 8 900 382 318



Calibration target set Mazda type 2

Article number: 8 900 381 234

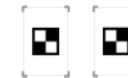

Calibration target set Mitsubishi type 1

Article number: 8 900 381 218



Calibration target Toyota type 1

Article number: 8 900 382 287



Calibration target Toyota type 2

Article number: 8 900 382 328

**Calibration target Toyota type 3**

Article number: 8 900 382 355

**ACC reflector mirror | for radar calibration**

Article number: 8 900 381 150

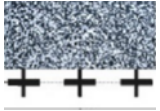
**Calibration target Subaru type 2S**

Article number: 8 900 382 608

**BBFAS 1415**

Article number: 8 900 380 007

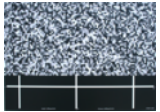
**Calibration target Subaru type 3S**

Article number: 8 900 382 590

**Calibration target Kia / Hyundai type 2**

Article number: 8 900 382 320

**Calibration target Kia / Hyundai type 3**

Article number: 8 900 382 316

**Calibration target Mercedes/Infiniti type 1**

Article number: 8 900 382 312

**Calibration target Mercedes / Infiniti type 2**

Article number: 8 900 382 319

**Calibration target Universal type 6S**

Article number: 8 900 382 571

**Calibration target set Universal type 2**

Article number: 8 900 381 142

**Target storage box empty**

Article number: 1 690 381 217

IMPORTANT NOTES

- Please notice: This list contains spare parts, too.
- Without instruction or assembly.
- Delivery ex works including packaging.

VERSION 2024.05.16 – PRICES ON REQUEST

- Starting from now all previous lists will lose their validity.
- Please read our general terms and conditions in the latest version before ordering; to be found under www.beissbarth.com.

Order number 1 693 602 008 **Print norm** BB XXX / XX.XX.2020 DE · Subject to technical and program changes, errors excepted.

Beissbarth Automotive Testing Solutions GmbH

Hanauer Straße 101
80993 Munich, Germany
sales@beissbarth.com
www.beissbarth.com

Telefon: +49-(0)89-14901-0
Telefax: +49-(0)89-14901-246

